

**Applications**

- Motor Control
- Overvoltage Crowbar Protection
- Capacitive Discharge Ignition
- Voltage Regulation
- Welding Equipment
- Capacitive Filter Soft Start (Inrush Current Control)

- Suitable for General Purpose AC Switching
- IGT 35mA Max.
- $V_{DRM}/V_{RMM}$  400, 600, 800, 1000V

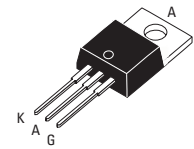

TO-220AB Non-Isolated

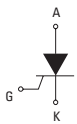

**Absolute Maximum Ratings**

	CONDITIONS	SYMBOL	RATING
RMS On-State Current (full sine wave) <sup>NOTE 1</sup>	$T_c = 90^\circ C$	TO-220AB $I_T(RMS)$	55A
Average On-State Current	$T_c = 90^\circ C$	TO-220AB $I_T(AV)$	35A
Non Repetitive Surge Peak On-State Current (Full Cycle, $T_j$ Initial = $25^\circ C$ )	F = 50 Hz F = 60 Hz	$I_{TSM}$	675A 700A
$I^2t$ Value for fusing	$t_p = 10$ ms	$I^2t$	2030A <sup>2</sup> s
Critical rate of rise of on-state current $I_G = 2 \times I_{GT}$ , $t_r < 100$ ns, $T_j = 125^\circ C$		$di/dt$	100A/ $\mu$ s
Peak Gate Current @ $T_j = 125^\circ C$	$t_p = 20$ $\mu$ s	$I_{GM}$	4A
Average Gate Power Dissipation @ $T_j = 125^\circ C$		$PG(AV)$	1W
Storage Temperature Range		$T_{stg}$	-40 to $+150^\circ C$
Operating Junction Temperature Range		$T_j$	-40 to $+125^\circ C$
Maximum Peak Reverse Gate Voltage		$V_{RGM}$	5V

**Electrical Characteristics** <sup>NOTE 1</sup>

$I_{GT}$ MAX @ $V_D = 12$ V, $R_L = 30\Omega$		35mA
$V_{GT}$ MAX @ $V_D = 12$ V, $R_L = 30\Omega$		1.3V
$V_{GD}$ MIN @ $V_D = V_{DRM}$ , $R_L = 3.3k\Omega$	$T_j = 125^\circ C$	0.2V
$I_H$ MAX @ $I_T = 500$ mA (gate open)		50mA
$I_L$ MAX @ $I_G = 1.2 I_{GT}$		90mA
$dv/dt$ MIN @ $V_D = 67\% V_{DRM}$ (gate open)	$T_j = 125^\circ C$	1000V/ $\mu$ s
$V_{TM}$ MAX @ $I_{TM} = 32$ A, $t_p = 380\mu$ s	$T_j = 25^\circ C$	1.6V
$I_{DRM}$ MAX @ $V_{DRM} = V_{RRM}$	$T_j = 25^\circ C$	5 $\mu$ A
$I_{RRM}$ MAX @ $V_{DRM} = V_{RRM}$	$T_j = 125^\circ C$	4mA

**GENERAL NOTES**

1. Not intended for continuous current use above 50ARMS (Fig 2); for high surge conditions only. Continuous use above 50ARMS may exceed PCB solder melting temperatures.
2. All parameters at 25 degrees C unless otherwise specified.

**Thermal Resistances**

		SYMBOL	RATING
Junction to Case (AC)	TO-220AB	$R_{th(j-c)}$	1.0°C/W
Junction to Ambient	TO-220AB	$R_{th(j-a)}$	60°C/W

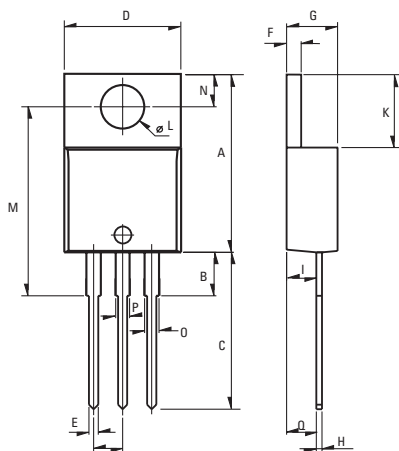

Weight: 2.3g (0.08 oz)

**Dimensions**

REF.	Millimeters			Inches		
	Min.	Typ.	Max.	Min.	Typ.	Max.
A	15.24		15.75	0.6		0.62
B		3.23			0.127	
C	12.78		13.79	0.503		0.543
D	9.96		10.36	0.392		0.408
E	0.69		0.94	0.027		0.037
F	1.22		1.32	0.048		0.052
G	4.62		4.83	0.182		0.19
H	0.46		0.61	0.018		0.024
I	2.49		2.84	0.098		0.112
J	2.39		2.69	0.094		0.106
K	6.48		6.88	0.255		0.271
L	3.78		3.89	0.149		0.153
M	15.49	16	16.51	0.61	0.63	0.65
N	2.59		2.9	0.102		0.114
O	0.99		1.55	0.039		0.061
P	0.99		1.55	0.039		0.061
Q		2.67			0.105	

**Part Number Designation**

**SERIES**  
**CYNB 55 - 800 PT**

Rated Current  
**55: 55 Amp**

Packaging  
**Blank: Bulk**  
**PT: Plastic Tube**

Maximum Blocking Voltage  
**400: 400Vpk**  
**600: 600Vpk**  
**800: 800Vpk**  
**1000: 1000Vpk**

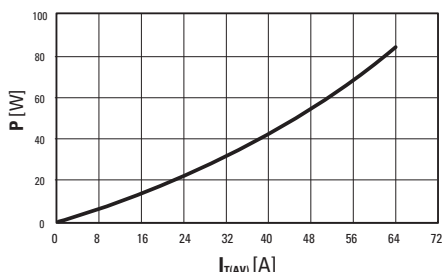

Fig. 1: Power dissipation versus average on-state current.

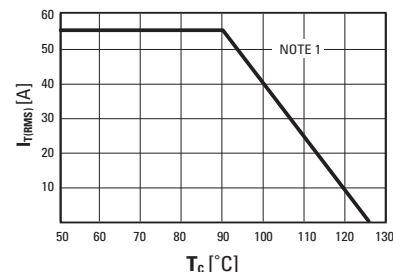

Fig. 2: RMS on-state current versus case temperature (full cycle)

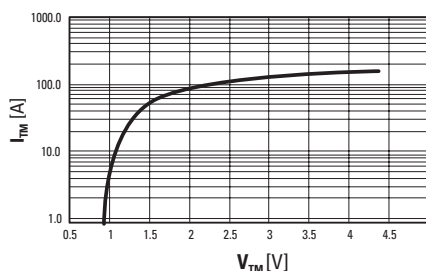

Fig. 3: On-state current versus on-state voltage (instantaneous values)

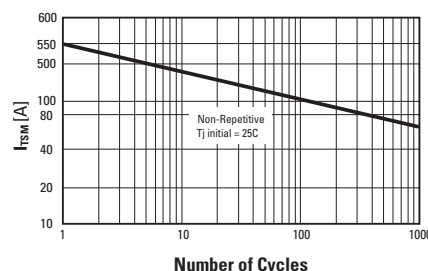

Fig. 4: Non-repetitive surge peak on-state current versus number of cycles.

ISO9001 CERTIFIED

**Approvals**

UL Recognized Component - E72445 (CYNA Series)

**USA**

Sales & Tech Support (866) 258-5057  
 Email: sales@cynergy3.com  
 Cynergy3 Components  
 2320 Paseo de las Americas, Suite 104  
 San Diego, CA 92154

**EUROPE - UK**

Telephone +44 (0) 1202 897969  
 Fax +44 (0) 1202 891918  
 Email: sales@cynergy3.com  
 Cynergy3 Components Ltd.  
 7 Cobham Road  
 Ferndown Industrial Estate  
 Wimborne, Dorset BH21 7PE

**ASIA - Thailand**

Telephone +66 (0)2 665 2517  
 Fax +66 (0)2 665 2588  
 Cynergy 3 Components, Asia  
 18/8 Fico Place 12th Floor  
 Soi Sukhumvit 21 (Asoke)  
 Klongtoey Nua, Wattana  
 Bangkok, Thailand 10110